

AXIS M3045-WV Network Camera

User Manual

AXIS M3045-WV Network Camera

Table of Contents

Product overview	3
How to connect the camera to a wireless network	4
How to manually configure the wireless network	4
How to access the product	4
Setup	6
About the product's built-in help	6
Image quality	6
Overlays	9
Streaming and storage	10
Events	11
Applications	12
Advanced wireless settings	13
Troubleshooting	15
How to reset to factory default settings	15
How to check the current firmware	15
How to upgrade the firmware	15
Technical issues, clues and solutions	16
Performance considerations	17
Specifications	18
LED Indicators	18
SD card slot	18
Buttons	18
Connectors	19

AXIS M3045-WV Network Camera

Product overview

Product overview

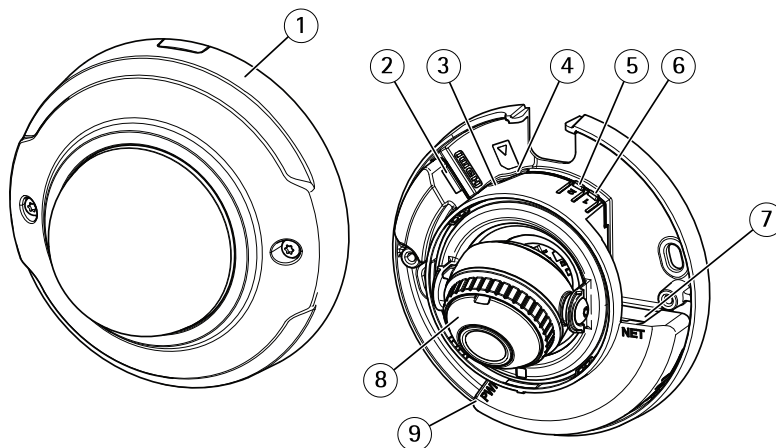

- 1 Dome cover
- 2 HDMI connector
- 3 Status LED
- 4 microSD card slot
- 5 WLAN pairing button (2)
- 6 Control button (1)
- 7 Network connector
- 8 Focus ring
- 9 Power Connector

AXIS M3045-WV Network Camera

How to connect the camera to a wireless network

How to connect the camera to a wireless network

1. Press and very quickly release the WLAN pairing button on the camera.
2. Press the WLAN pairing button on the wireless access point within 120 seconds from pushing the button on the camera.
3. Make sure the LED indicator shows steady green for 10 seconds, this means that the camera is connected.
4. Go to **Settings > System > Wireless** and turn the WLAN pairing button off to prevent unauthorized WLAN pairing.

If the wireless access point does not support push-button configuration, you have to configure the wireless network manually, see *How to manually configure the wireless network*.

How to manually configure the wireless network

1. Use a network cable to connect the camera to the network.
2. Make sure the access point is up and running.
3. Log in to the product's webpages, see *How to access the product on page 4*.
4. Go to **Settings > System > Wireless**.
5. In the list, select the wireless network or go to **Add another network** and add it manually with the SSID.
6. Enter the password for the access point.
7. Click **Save**.
8. Disconnect the network cable from the camera.
9. Make sure the LED indicator shows steady green for 10 seconds, this means that the camera is connected.

If the network is set up with another security method than WPA2-PSK, see *Advanced wireless settings on page 13*.

How to access the product

AXIS IP Utility and AXIS Camera Management are recommended methods for finding Axis products on the network and assigning them IP addresses in Windows®. Both applications are free and can be downloaded from axis.com/support

The product can be used with the following browsers:

- Chrome™ (recommended), Firefox®, Edge®, or Opera® with Windows®
- Chrome™ (recommended) or Safari® with OS X®
- Chrome™ or Firefox® with other operating systems.

If you need more information about recommended browsers, go to axis.com/browser-support

How to access the product from a browser

1. Start a web browser.
2. Enter the IP address or host name of the Axis product in the browser's address field.

To access the product from a Mac computer (OS X), go to Safari, click on Bonjour and select the product from the drop-down list. To add Bonjour as a browser bookmark, go to **Safari > Preferences**.

AXIS M3045-WV Network Camera

How to connect the camera to a wireless network

If you do not know the IP address, use AXIS IP Utility to locate the product on the network. For information about how to discover and assign an IP address, see the document *Assign an IP Address and Access the Video Stream* on Axis Support web at axis.com/support

3. Enter your username and password. If this is the first time the product is accessed, the root password must first be configured.
4. The product's live view page opens in your browser.

About secure passwords

Important

When setting the initial password, the password is sent in clear text over the network. If there is a risk of network sniffing, first set up a secure and encrypted HTTPS connection before resetting the passwords.

The device password is the primary protection for the data and services. Axis' devices do not impose a password policy as devices may be used in various types of installations, but to protect your data do the following:

- Don't use the default password that comes with the devices.
- Use a password with at least 8 characters, preferably using a password generator.
- Don't expose the password.
- Change password at a recurring interval, at least once a year.

Set a password for the root account

Important

The default administrator user name `root` cannot be deleted. If the password for root is lost, the device must be reset to the factory default settings.

The default root account has full privileges and should be reserved for administrative tasks. Always create a user account with limited privileges for daily use. This reduces the exposure of the administrative account.

1. Make sure to follow the instructions about secure passwords, see *About secure passwords on page 5*.
2. Type a password and then retype it to confirm the spelling.
3. Click `Create login`. The password has now been configured.

AXIS M3045-WV Network Camera

Setup

Setup

About the product's built-in help

You can access the built-in help through your product's web page. The help provides more detailed information on the product's features and their settings.

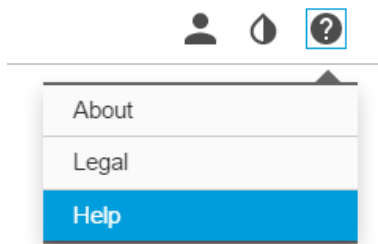

Image quality

About capture modes

How to select capture mode

Which capture mode to choose depends on the requirements of frame rate and resolution for the specific surveillance setup. For specifications about available capture modes, see the product's datasheet. To find the latest version of the datasheet, go to axis.com

How to select exposure mode

There are several exposure mode options in the camera that adjusts aperture, shutter speed, and gain to improve image quality for specific surveillance scenes. Go to **Settings > Image > Exposure** and select between the following exposure modes:

Exposure Settings

Exposure is the amount of light the camera's sensor captures for a scene. Too much light results in a washed out image and too little light results in a dark image.

Configure the exposure settings to suit the image quality requirements in relation to lighting, frame rate and bandwidth considerations.

Exposure value – Click in the bar to fine-tune the exposure.

Exposure control – Select a suitable option to control exposure.

For most scenes, the **Automatic** option will provide the best results. The shutter speed is automatically set to produce optimum image quality.

Fluorescent lamps or other light sources can sometimes cause flickering in the image. To reduce flicker in the image, select the **Flicker** option that matches the power line frequency.

The **Hold current** option locks the current exposure settings.

About view area

A view area is a cropped part of the full view. You can stream and store view areas instead of the full view to minimize bandwidth and storage needs. If you enable PTZ for a view area, you can pan, tilt and zoom within it. By using view areas you can remove parts of the full view, for example, the sky.

AXIS M3045-WV Network Camera

Setup

When you set up a view area, we recommend you to set the video stream resolution to the same size as or smaller than the view area size. If you set the video stream resolution larger than the view area size it implies digitally scaled up video after sensor capture, which requires more bandwidth without adding image information.

How to hide parts of the image with privacy masks

If you want to hide parts of the image due to privacy reasons, use one or several privacy masks.

What is a privacy mask?

A privacy mask is a user-defined area that prohibits users from viewing parts of the monitored area. Privacy masks appear as blocks of solid color and are applied on the video stream.

Privacy masks are present on all snapshots, recorded video, and requested streams. They can not be bypassed through the VAPIX® application programming interface (API).

Important

If you add multiple privacy masks, this may affect the product's performance.

Note

To view privacy masks in video over HDMI the video stream must be restarted every time the product is restarted.

How to create a privacy mask

To create or edit a privacy mask, go to **Settings > Privacy mask**.

How to enhance facial recognition

To better recognize the face of a person passing by the camera, you can set the optimal pixel resolution with the camera's pixel counter.

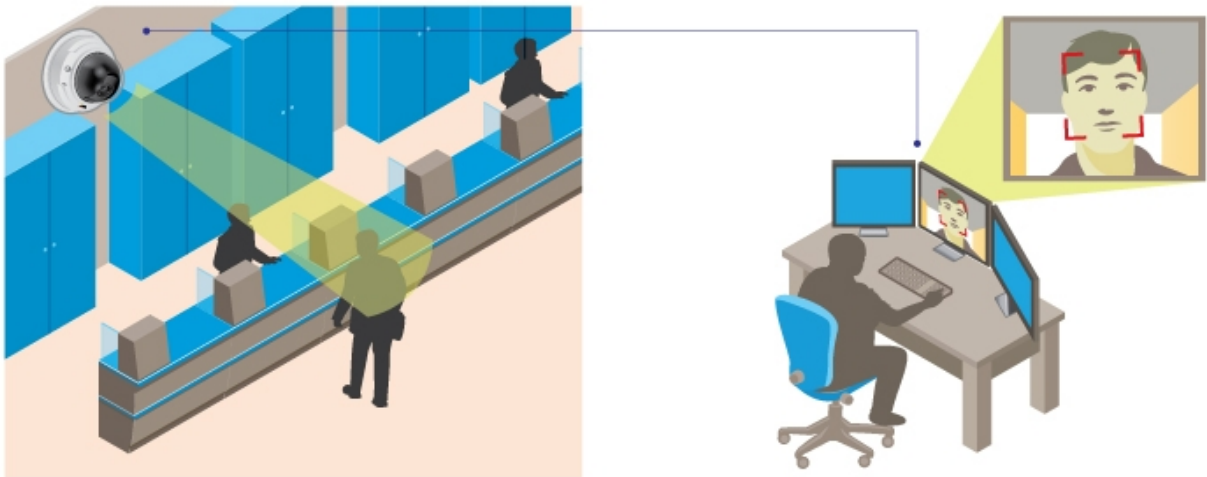

1. Go to **Settings > System > Orientation** and click .
2. Adjust the size and placement of the rectangle in the camera's live view around the area of interest, for example where the faces of passing persons are expected to appear. You can then see the number of pixels represented by the sides of the rectangle.

Note

You can use an object of a known size in the view as a reference to decide how much resolution is needed for recognition.

AXIS M3045-WV Network Camera

Setup

How to monitor long and narrow areas

Use corridor format to better utilize the full field of view in a long and narrow area, for example a staircase, hallway, road, or tunnel.

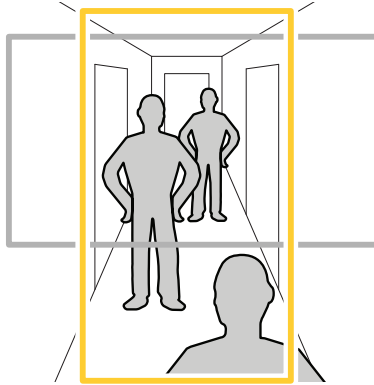

1. Depending on your product, turn the camera or the 3-axis lens in the camera 90° or 270°.
2. Go to **Settings > Stream > Orientation** on the product's webpage and rotate the view 90° or 270°.

Find out more at axis.com/axis-corridor-format

How to reduce noise in low-light conditions

To reduce noise in low-light conditions, you can adjust one or more of the following settings:

Note

Increasing the max shutter value can result in motion blur.

- The shutter speed should be as slow as possible, which means you should set max shutter to the highest possible value.
- Reduce sharpness in the image.

How to handle scenes with strong backlight

Use WDR to make both dark and bright areas of the image visible.

1. Go to **Settings > Image**.
2. Turn on WDR under **Wide dynamic range**.



Image without WDR.

AXIS M3045-WV Network Camera

Setup



Image with WDR.

Note

If you use WDR, you may experience some WDR artifacts in the image.

Find out more about WDR and how to use it at axis.com/web-articles/wdr

How to maximize details in an image

Important

If you maximize details in an image, bitrate increases and might lead to reduced frame rate.

- Make sure to select capture mode that has the highest resolution.
- Set compression as low as possible.
- Select MJPEG streaming.
- Turn off the Zipstream functionality.

Overlays

About overlays

Note

Image and text overlay will not be displayed on video stream over HDMI.

Overlays are superimposed over the video stream. They are used to provide extra information during recordings, such as a timestamp, or during product installation and configuration.

How to show a text overlay when the camera detects motion

This example explains how to display the text "Motion detected" when the camera detects motion:

Make sure the AXIS Video Motion Detection application is running:

1. Go to **Settings > Apps > AXIS Video Motion Detection**.
2. Start the application if it is not already running.
3. Make sure you have set up the application according to your needs.

Add the overlay text:

4. Go to **Settings > Overlay**.

AXIS M3045-WV Network Camera

Setup

5. Enter #D in the text field.
6. Choose alignment, text size and appearance.
7. **Include** the text overlay.

Create an action rule:

8. Go to **System > Events > Action rules**.
9. Create an action rule with **AXIS Video Motion Detection** as trigger.
10. From the list of actions, select **Overlay text**.
11. Type "Motion detected".
12. Set the duration.

Streaming and storage

How to choose video compression format

Decide which compression method to use based on your viewing requirements, and on the properties of your network. The available options are:

Motion JPEG

Motion JPEG or MJPEG is a digital video sequence that is made up of a series of individual JPEG images. These images are then displayed and updated at a rate sufficient to create a stream that shows constantly updated motion. For the viewer to perceive motion video the rate must be at least 16 image frames per second. Full motion video is perceived at 30 (NTSC) or 25 (PAL) frames per second.

The Motion JPEG stream uses considerable amounts of bandwidth, but provides excellent image quality and access to every image contained in the stream.

H.264 or MPEG-4 Part 10/AVC

Note

H.264 is a licensed technology. The Axis product includes one H.264 viewing client license. Installing additional unlicensed copies of the client is prohibited. To purchase additional licenses, contact your Axis reseller.

H.264 can, without compromising image quality, reduce the size of a digital video file by more than 80% compared to the Motion JPEG format and by as much as 50% compared to the MPEG-4 standard. This means that less network bandwidth and storage space are required for a video file. Or seen another way, higher video quality can be achieved for a given bitrate.

H.265 or MPEG-H Part 2/HEVC

Note

H.265 is licensed technology. The Axis product includes one H.265 viewing client license. Installing additional unlicensed copies of the client is prohibited. To purchase additional licenses, contact your Axis reseller.

How to view live video stream on a monitor

Your camera can transmit live video stream to an HDMI monitor without a network connection. The monitor can be used for surveillance purposes or for public viewing e.g. in a store.

1. Connect an external monitor using the HDMI connector.
2. Change the HDMI settings under **Settings > Stream > HDMI**.

AXIS M3045-WV Network Camera

Setup

How to reduce bandwidth and storage

Important

If you reduce the bandwidth it can result in loss of details in the picture.

1. Go to live view and select **H.264/H.265**.
2. Go to **Settings > Stream**.
3. Do one or more of the following:
 - Turn on the Zipstream functionality and select the desired level.

Note

The zipstream settings are used for both H.264 and H.265.

- Turn on dynamic GOP and set a high GOP length value.
- Increase the compression.
- Turn on dynamic FPS.

How to set up network storage

To store recordings on the network, you need to set up network storage:

1. Go to **Settings > System > Storage**.
2. Click **Setup** under **Network storage**.
3. Enter the IP address of the host server.
4. Enter the name of the shared location on the host server.
5. Move the switch if the share requires a login, and enter username and password.
6. Click **Connect**.

Events

About events

The event pages allow you to configure your product to perform actions when different events occur. For example, the product can start a recording or send an email notification when motion is detected. The set of conditions that defines how and when the action is triggered is called an action rule.

How to trigger an action

1. Go to **Settings > System > Events** to set up an action rule. The action rule defines when the product will perform certain actions. Action rules can be setup as scheduled, recurring, or for example, triggered by motion detection.
2. Select what **Trigger** must be met to trigger the action. If you specify more than one trigger for the action rule, all of them must be met to trigger the action.
3. Select which **Action** the camera should perform when the conditions are met.

Note

If you make changes to an active action rule, the action rule needs to be restarted for the changes to take effect.

AXIS M3045-WV Network Camera

Setup

How to record video when the camera detects motion

This example explains how to set up the camera to start recording to the SD card five seconds before it detects motion and to stop one minute after.

Make sure the AXIS Video Motion Detection application is running:

1. Go to **Settings > Apps > AXIS Video Motion Detection**.
2. Start the application if it is not already running.
3. Make sure you have set up the application according to your needs.

Create an action rule:

4. Go to **Settings > System > Events** and add an action rule.
5. Type a name for the action rule.
6. From the list of triggers, select **Applications** and then select **AXIS Video Motion Detection (VMD)**.
7. From the list of actions, select **Record video**.
8. Select an existing stream profile or create a new one.
9. Set the pre-trigger time to 5 seconds.
10. Set the post-trigger time to 60 seconds.
11. Select **SD card** from the list of storage options.
12. Click **Ok**.

Applications

About applications

AXIS Camera Application Platform (ACAP) is an open platform that enables third parties to develop analytics and other applications for Axis products. To find out more about available applications, downloads, trials and licenses, go to axis.com/applications

To find the user manuals for Axis applications, go to axis.com

Note

- Several applications can run at the same time but some applications might not be compatible with each other. Certain combinations of applications might require too much processing power or memory resources when run in parallel. Verify that the applications work together before deployment.

AXIS People Counter

AXIS People Counter is an analytic application that can be installed on a network camera.

The counter is embedded in the camera which means you do not need a dedicated computer to run the application.

AXIS People Counter is intended for retail environments, like stores or shopping malls, or other environments where you want to count people.

AXIS M3045-WV Network Camera

Setup

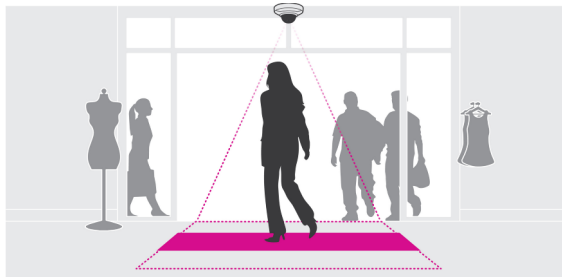

Advanced wireless settings

The most common security method is WPA-/WPA2-PSK. This product also supports WPATM-/WPA2TM-Enterprise which is a more secure method. All settings must match the settings in the access point.

WPATM-/WPA2TM-PSK

The security method WPA-/WPA2-PSK is designed for small networks and does not require an authentication server. The Axis product uses a PSK (Pre-Shared Key) to authenticate with the access point. The key can be entered either as manual hex — a 64 hexadecimal number (0–9, A–F) — or a passphrase using 8–63 ASCII characters. The longer the passphrase, the more secure is the key.

WPATM-/WPA2-Enterprise

The security method WPA-/WPA2-Enterprise is designed for large networks and requires an authentication server. The network is protected by EAPOL (Extensible Authentication Protocol Over Lan).

Select the WPA-Enterprise type being used by the access point:

- EAP-TLS. See *page 13*.
- EAP-PEAP/MSCHAPv2. See *page 14*.

About EAP-TLS

The authentication protocol EAP-TLS (Extensible Authentication Protocol - Transport Layer Security) allows the client and server to authenticate each other using digital certificates provided by a Certification Authority. To gain access to the protected network, the Axis product presents its certificate to the network access point. Access is granted if the certificate is approved.

Important

To ensure successful certificate validation, time synchronization should be performed on all clients and servers prior to configuration.

How to configure the wireless settings using WPATM-/WPA2-Enterprise and EAP-TLS

1. Go to **Settings > System > Wireless**
2. In the list, select the wireless network.
3. Under **WPA-Enterprise type**, select **EAP-TLS**.
4. Enter the user **Identity** associated with your certificate.
5. Select the **EAPOL version** (1 or 2) as used in the access point.
6. Select the **CA certificate** and the **client certificate** to use for wireless authentication.
7. Click **Save**.

AXIS M3045-WV Network Camera

Setup

About EAP-PEAP/MSCHAPv2

The authentication protocol EAP-PEAP/MSCHAPv2 (Extensible Authentication Protocol – Protected Extensible Authentication Protocol/Microsoft Challenge Handshake Authentication Protocol) allows the client to authenticate the network using a digital certificate provided by a Certification Authority. The network authenticates the client using an identity and a password. To gain access to the protected network, the Axis product presents its identity and password to the network access point. If these credentials are approved, the access point allows access on a preconfigured port.

Important

To ensure successful certificate validation, time synchronization should be performed on all clients and servers prior to configuration.

How to configure the wireless settings using WPA™-/WPA2-Enterprise and EAP-PEAP/MSCHAPv2

1. Go to **Settings > System > Wireless**
2. In the list, select the wireless network.
3. Under **WPA-Enterprise protocol**, select **EAP-PEAP/MSCHAPv2**.
4. Enter the user **Identity** associated with your certificate.
5. Enter the **Password** for your user identity.
6. Select the **PEAP Version (0 or 1)** as used in the access point.
7. Select the **PEAP Label** that the access point uses when using PEAP version 1. Select 1 to use client EAP encryption; select 2 to use client PEAP encryption.
8. Select the **EAPOL version (1 or 2)** as used in the access point.
9. Select the **CA certificate** with which to validate the network/AP certificate.
10. Click **Save**.

About wireless certificates

Wireless network certificates are used to authenticate devices on a wireless network. Wireless networks using the WPA™-/WPA2-Enterprise security method are protected by EAPOL (Extensible Authentication Protocol Over Lan), which is part of the IEEE 802.1X standard. The client authenticates the server using digital certificates. The server authenticates the client using digital certificates or a password depending on the selected WPA-Enterprise type.

AXIS M3045-WV Network Camera

Troubleshooting

Troubleshooting

How to reset to factory default settings

Important

Reset to factory default should be used with caution. A reset to factory default resets all settings, including the IP address, to the factory default values.

To reset the product to the factory default settings:

1. Disconnect power from the product.
2. Press and hold the control button while reconnecting power. See *Product overview*.
3. Keep the control button pressed for 15–30 seconds until the status LED indicator flashes amber.
4. Release the control button. The process is complete when the status LED indicator turns green. The product has been reset to the factory default settings. If no DHCP server is available on the network, the default IP address is 192.168.0.90
5. Use the installation and management software tools to assign an IP address, set the password, and access the video stream.

The installation and management software tools are available from the support pages on axis.com/support

It is also possible to reset parameters to factory default via the web interface. Go to **Settings > System > Maintenance** and click **Default**.

How to check the current firmware

Firmware is the software that determines the functionality of network devices. One of your first actions when troubleshooting a problem should be to check the current firmware version. The latest version may contain a correction that fixes your particular problem.

To check the current firmware:

1. Go to the product's webpage.
2. Click on the help menu. 
3. Click **About**.

How to upgrade the firmware

Important

Preconfigured and customized settings are saved when the firmware is upgraded (provided that the features are available in the new firmware) although this is not guaranteed by Axis Communications AB.

Important

Make sure the product remains connected to the power source throughout the upgrade process.

Note

When you upgrade the product with the latest firmware, the product receives the latest functionality available. Always read the upgrade instructions and release notes available with each new release before upgrading the firmware. To find the latest firmware and the release notes, go to axis.com/support/firmware

1. Download the latest firmware file to your computer, available free of charge at axis.com/support/firmware

AXIS M3045-WV Network Camera

Troubleshooting

2. Log in to the product as an administrator.
3. Go to **Settings > System > Maintenance** in the product's webpage and follow the instructions. When the upgrade has finished, the product restarts automatically.

AXIS Camera Management can be used for multiple upgrades. Find out more at axis.com/products/axis-camera-management

Technical issues, clues and solutions

If you can't find what you're looking for here, try the troubleshooting section at axis.com/support

Problems upgrading the firmware

Firmware upgrade failure	If the firmware upgrade fails, the product reloads the previous firmware. The most common reason is that the wrong firmware file has been uploaded. Check that the name of the firmware file corresponds to your product and try again.
--------------------------	---

Problems setting the IP address

The product is located on a different subnet	If the IP address intended for the product and the IP address of the computer used to access the product are located on different subnets, you cannot set the IP address. Contact your network administrator to obtain an IP address.
--	---

The IP address is being used by another device	Disconnect the Axis product from the network. Run the ping command (in a Command/DOS window, type <code>ping</code> and the IP address of the product): <ul style="list-style-type: none">• If you receive: <code>Reply from <IP address>: bytes=32; time=10...</code> this means that the IP address may already be in use by another device on the network. Obtain a new IP address from the network administrator and reinstall the product.• If you receive: <code>Request timed out</code>, this means that the IP address is available for use with the Axis product. Check all cabling and reinstall the product.
--	---

Possible IP address conflict with another device on the same subnet	The static IP address in the Axis product is used before the DHCP server sets a dynamic address. This means that if the same default static IP address is also used by another device, there may be problems accessing the product.
---	---

The product cannot be accessed from a browser

Cannot log in	When HTTPS is enabled, ensure that the correct protocol (HTTP or HTTPS) is used when attempting to log in. You may need to manually type <code>http</code> or <code>https</code> in the browser's address field.
---------------	--

If the password for the user `root` is lost, the product must be reset to the factory default settings. See *How to reset to factory default settings*.

The IP address has been changed by DHCP	IP addresses obtained from a DHCP server are dynamic and may change. If the IP address has been changed, use AXIS IP Utility or AXIS Camera Management to locate the product on the network. Identify the product using its model or serial number, or by the DNS name (if the name has been configured).
---	---

If required, a static IP address can be assigned manually. For instructions, go to axis.com/support.

Certificate error when using IEEE 802.1X	For authentication to work properly, the date and time settings in the Axis product must be synchronized with an NTP server. Go to Settings > System > Date and time
--	---

The product is accessible locally but not externally

Router configuration	Check that your router allows incoming data traffic to the Axis product. The router must support UPnP®.
----------------------	---

Firewall protection	Check the Internet firewall with your network administrator.
---------------------	--

AXIS M3045-WV Network Camera

Troubleshooting

Problems with streaming

Multicast H.264 only accessible by local clients	Check if your router supports multicasting, or if the router settings between the client and the product need to be configured. The TTL (Time To Live) value may need to be increased.
No multicast H.264 displayed in the client	Check with your network administrator that the multicast addresses used by the Axis product are valid for your network. Check with your network administrator to see if there is a firewall preventing viewing.
Poor rendering of H.264 images	Ensure that your graphics card is using the latest driver. The latest drivers can usually be downloaded from the manufacturer's website.
Color saturation is different in H.264 and Motion JPEG	Modify the settings for your graphics adapter. Go to the adapter's documentation for more information.
Lower frame rate than expected	<ul style="list-style-type: none">• See <i>Performance considerations on page 17</i>.• Reduce the number of applications running on the client computer.• Limit the number of simultaneous viewers.• Check with the network administrator that there is enough bandwidth available.• Lower the image resolution.• In the product's webpage, set a capture mode that prioritizes frame rate. Changing the capture mode to prioritize frame rate might lower the maximum resolution depending on the product used and capture modes available.• The maximum frames per second is dependent on the utility frequency (60/50 Hz) of the Axis product.
Can't select H.265 encoding in live view	Web browsers do not support H.265 decoding. Use a video management system or application supporting H.265 decoding.

Performance considerations

When setting up your system, it is important to consider how various settings and situations affect the performance. Some factors affect the amount of bandwidth (the bitrate) required, others can affect the frame rate, and some affect both. If the load on the CPU reaches its maximum, this also affects the frame rate.

The following factors are the most important to consider:

- High image resolution or lower compression levels result in images containing more data which in turn affects the bandwidth.
- Access by large numbers of Motion JPEG or unicast H.264 clients affects the bandwidth.
- Simultaneous viewing of different streams (resolution, compression) by different clients affects both frame rate and bandwidth.

Use identical streams wherever possible to maintain a high frame rate. Stream profiles can be used to ensure that streams are identical.
- Accessing Motion JPEG and H.264 video streams simultaneously affects both frame rate and bandwidth.
- Heavy usage of event settings affects the product's CPU load which in turn affects the frame rate.
- Using HTTPS may reduce frame rate, in particular if streaming Motion JPEG.
- Heavy network utilization due to poor infrastructure affects the bandwidth.
- Viewing on poorly performing client computers lowers perceived performance and affects frame rate.
- Running multiple AXIS Camera Application Platform (ACAP) applications simultaneously may affect the frame rate and the general performance.
- Use 5 GHz rather than 2.5 GHz (5 GHz is typically less "crowded") and keep the distance to the access point short and free of obstacles (to improve the air path).

AXIS M3045-WV Network Camera

Specifications

Specifications

To find the latest version of the product's datasheet, go to the product page on axis.com and locate **Support & Documentation**.

LED Indicators

Note

- The Status LED can be configured to flash while an event is active.
- The Status LED can be configured to flash for identifying the unit. Go to **Setup > System Options > Maintenance**.

Status LED	Indication
Unlit	Connection and normal operation.
Green	Shows steady green for 10 seconds for normal operation after startup completed. Flashes green during wireless network pairing.
Amber	Steady during startup. Flashes during firmware upgrade or reset to factory default.
Amber/Red	Flashes amber/red if network connection is unavailable or lost.
Red	Firmware upgrade failure.

Note

Amber is a combination of red and green, and can be perceived as either of these colors depending on viewing angle.

SD card slot

NOTICE

- Risk of damage to SD card. Do not use sharp tools, metal objects, or excessive force when inserting or removing the SD card. Use your fingers to insert and remove the card.
- Risk of data loss and corrupted recordings. Do not remove the SD card while the product is running. Unmount the SD card from the product's webpage before removal.

This product supports microSD/microSDHC/microSDXC cards (not included).

For SD card recommendations, see axis.com

Buttons

Control button

The control button is used for:

- Resetting the product to factory default settings. See *How to reset to factory default settings on page 15*.
- Connecting to an AXIS Video Hosting System service. To connect, press and hold the button for about 3 seconds until the status LED flashes green.

WLAN pairing button

The WLAN pairing button is used for connecting to an access point through push button configuration (PBC). To find out more, go to .

AXIS M3045-WV Network Camera

Specifications

Connectors

HDMI connector

Use the HDMI™ connector to connect a display or public view monitor.

Network connector

RJ45 Ethernet connector.

